

## Shadowline Handle Kits

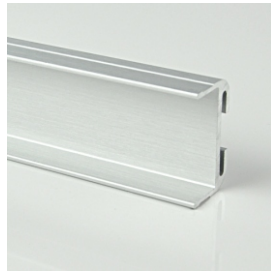

silver brushed anodized

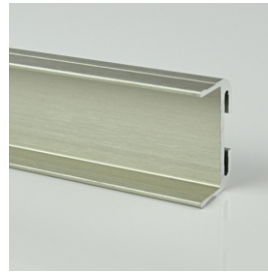

nickel brushed anodized



black brushed anodized



Clear anodized



white powder coated



black powder coated

### 42mm Shadowline Notch Details:

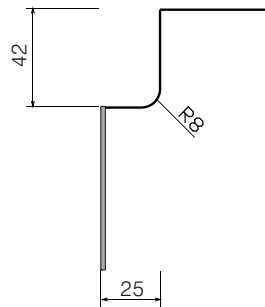

Edge banding Inc.

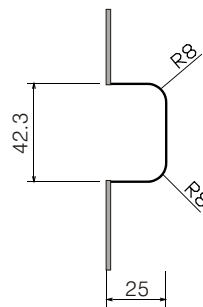

Edge banding Inc.

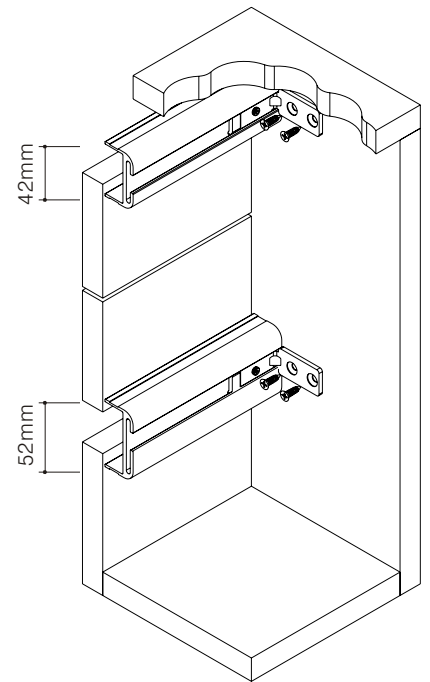

Cat No.	Length (mm)	Finish
2111. 38. 360	3700*	Clear anodized
2111. 37. 360	3700*	silver brushed anodized
2111. 36. 360	3700*	black brushed anodized
2111. 35. 360	3700*	nickel brushed anodized
2111. 31. 360	3700*	white powder coated
2111. 30. 360	3700*	black powder coated

Packing: 1set

\* Usable length 3630~3670mm

### 42mm Shadowline Kit components

Items	Name	Description	Quantity
	Handle profile	Aluminium, 3600mm	1 lth
	End clip	Steel, zinc-plated	2 pcs
	End cap	Zinc alloy	2 pcs

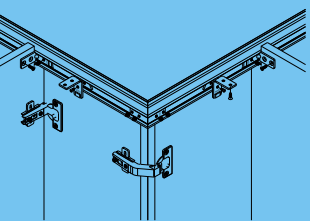
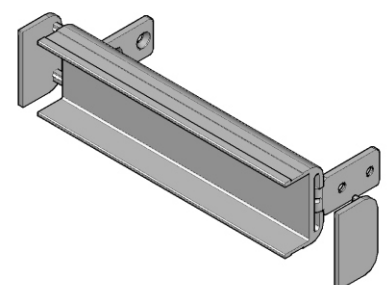

Dimensional Data not binding.  
We reserve the right to alter specifications without notice.

Note: Additional clips and cap can be ordered separately.